

**Profiles of rubber, sponge rubber,  
silicone, foam silicone**

buffer profiles

**BP**

# Solid rubber or Soft-PVC

## Legend

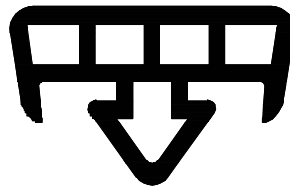

9999

means

Profile-No.

EP / s / 9999

means

Quality / Colour / Article-No

### Quality

CR	Neoprene
EP	EPDM
NBR	Perbunan
NK	Natural rubber
Si	Silicone
SPS	Foam silicone
FPM	VITON®
PVC	Soft-PVC
EVA	Ethylenvinylacetat
SBR	Buna (Styrol-Butadien)

### Colours

s	black
g	grey
w	white
az	anthracite
bg	beige
br	brown
hg	light-grey
rb	red-brown
t	translucent
r	red
x	colour selectable

® = Entered registered trade mark of the company DuPont

---

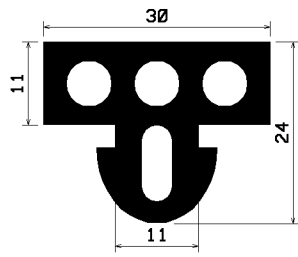

139  
EP/s/ 1620  
NK/w/1621

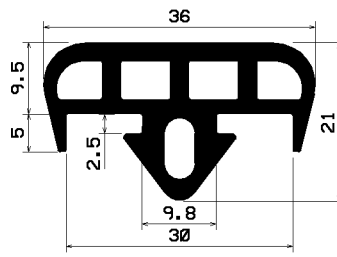

140  
EP/s/ 1619  
EP/w/ 3956

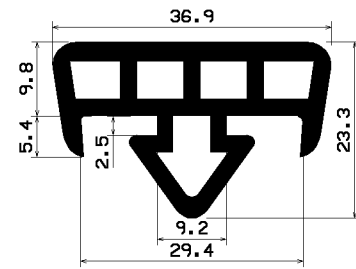

140/1  
EP/s/ 6035

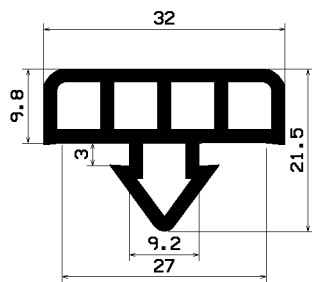

140/2  
EP/s/ 6489

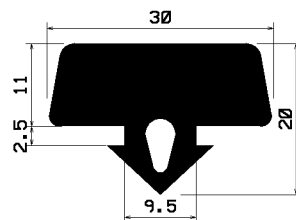

319  
EP/s/ 3346  
Si/t/ 7671

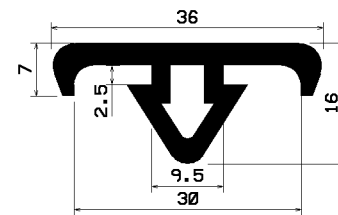

1131  
EP/s/ 3740

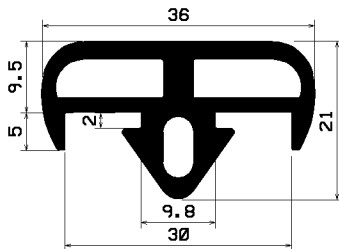

1528  
EP/s/ 4883

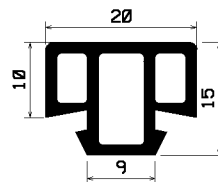

1531  
EP/g/ 4761

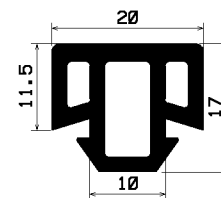

1549  
EP/g/ 4803

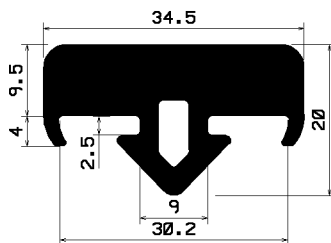

1583  
EP/s/ 5784

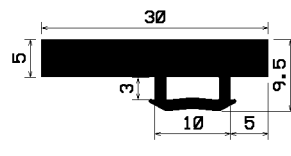

1690  
EP/s/ 5748

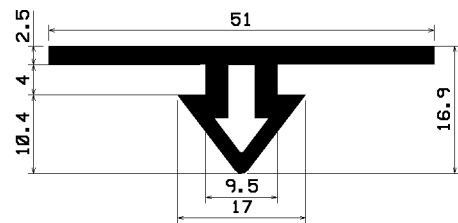

1938  
Si/t/ 6672

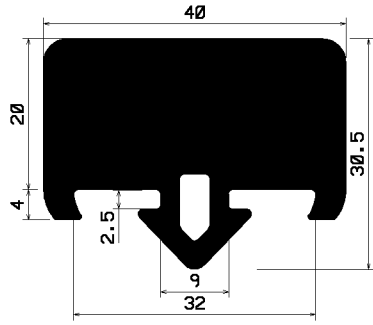

2103  
EP/s/ 7280

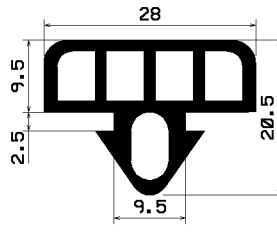

2324  
EP/s/ 8072